

LINIO NEON 360°

Indoor/Outdoor · All-direction Bending · 360° Emitting

Beamever

Features

- Low voltage 24V DC
- Diameter of 25mm
- Multiple mounting accessories for any design needs
- 360° emitting provides unparalleled creative possibilities
- High-grade Dow Corning silicone
- High-quality Lumileds LED chips



Fixture type	
Project name	
Project phase	
Date	



Dimension & Bending

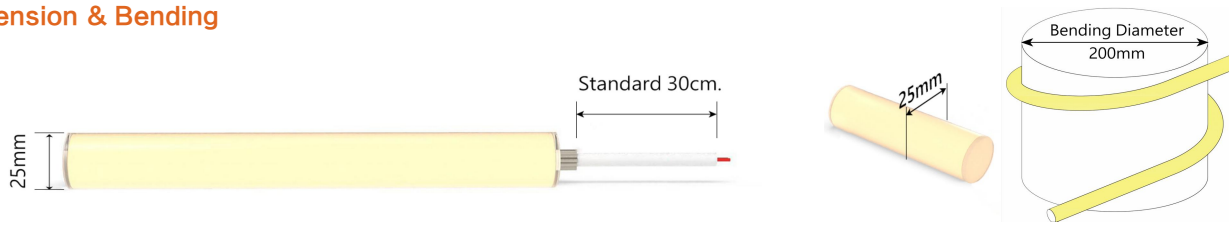

Physical

Dimensions	25mm (diameter)
Bend Direction	All-direction bending
Bend Diameter	200mm
Cutting Interval	50mm
Field Cuttable	No
Housing Material	Dow Corning
Housing Technique	Tubing
Body Color	White
Finish	Matte
Feed Entry	Front, side
Feed Length	Standard length 30cm
End Cap	Injected (Factory made only)
Mounting	21 types of mounting accessories
Storage Temperature	-40~60°C (-40~140°F)
Ambient Temperature	-40~60°C (-40~140°F)
Max. Production Length	5m

Performance & Electrical

Voltage	24VDC (23.5Vmin, 24.5Vmax)
Beam Angle	360°
MacAdam	2 steps
Efficacy (lm/W)	60lm/W @4000K 5W
CRI	Ra90
Lumen Maintenance	> 54,000 hours
IP Rating	IP65
Resistance	UV, solvent, saltwater, flame
Dimming	PWM, 0-10V, DMX
Control Protocol	N/A
Warranty	5 years

Certification & Safety

Certifications	UL, CE, RoHS, REACH, CB
Environment	Dry or damp locations

Lumen/m	5W	10W
■ 2700K	364	727
■ 3000K	362	733
■ 3500K	365	743
■ 4000K	366	744
■ 6000K	365	745
Max. Run Length(m)	5	5

LINIO NEON 360°

Indoor/Outdoor · All-direction Bending · 360° Emitting



Order Code

Series	Temp./Color	Power	Feed Entry	Connector Wire	End Cap	Length(mm)
LN360	27=2700K 30=3000K 35=3500K 40=4000K 60=6000K	005=5W 010=10W	FC=Front + Closed SC=Side+ Closed *Only available for feed entry in one side	OW=Open wire 30cm MLC=Male connector 30cm FLC=Female connector 30cm	IJ=Injected end cap (IP65)	Min. - 50mm Max. - 5000mm Cut Inc. - 50mm

Example: LN360-27-005-FC-OW-IJ-05000

* Customizable—Contact Beamever representatives

Channels or clips

Code	Description
LN360-SFC-O	Surface mount clear bracket - open clip
LN360-SPC-C	Suspended mount clear bracket - closed clip
LN360-TLC-L	Telescoping clear bracket - low profile clip
LN360-VB	Vertical surface mount bracket - black
LN360-UB	U-shaped surface mount bracket - black

* For customization, please specify your demands to your Beamever representatives.

Accessories (Optional)

Code	Description
MFC-2P-67	Male and female connectors with 30cm cable, IP67, 2 pin

* Please refer to "Accessories options" for more models available.

Power supplies

Code	Description
XLG-150-24-A	PSU 24V/150W IP67, Non dimmable, White
ELG-150-24B-3Y	PSU 24V/150W IP67, 3 in 1 dimming function
ELG-150-24DA-3Y	PSU 24V/150W IP67, DALI control technology

* Please refer to "Power supplies options" for more models available.

Note

* Leave your comments or other customized demands (if any) and contact Beamever.

Feed Entry Options

Front feed entry (F)



Side feed entry (S)



Closed feed entry (C)



LINIO NEON 360°

Indoor/Outdoor · All-direction Bending · 360° Emitting



Mounting Options

Surface mount clear bracket - open clip

Code LN360-SFC-O

Mounting Type

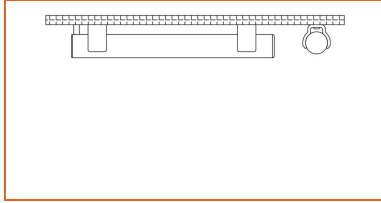

Surface mount clear bracket - closed clip

Code LN360-SFC-C

Mounting Type

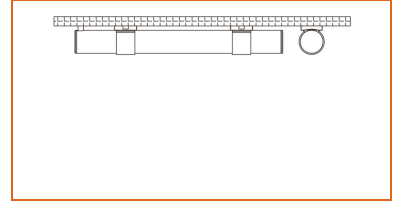

Surface mount clear bracket - low profile clip

Code LN360-SFC-L

Mounting Type

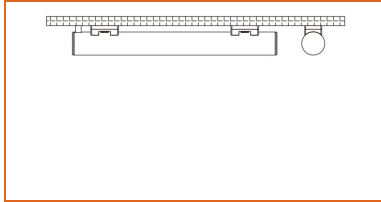
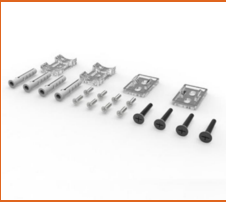

Surface mount clear bracket - PC channel

Code LN360-SFC-PC

Mounting Type

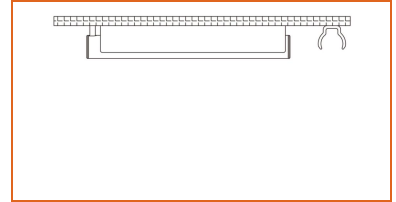

Suspended mount clear bracket - open clip

Code LN360-SPC-O

Mounting Type

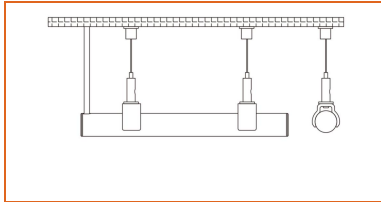

Suspended mount clear bracket - closed clip

Code LN360-SPC-C

Mounting Type

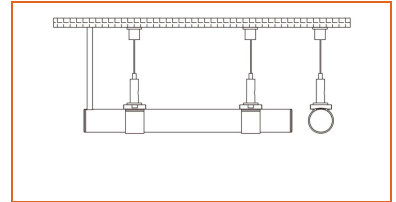

Suspended mount clear bracket - low profile clip

Code LN360-SPC-L

Mounting Type

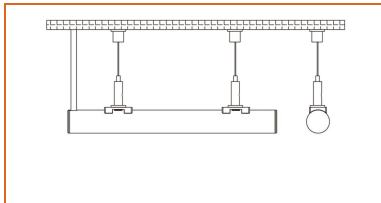

Suspended mount clear bracket - PC channel

Code LN360-SPC-PC

Mounting Type

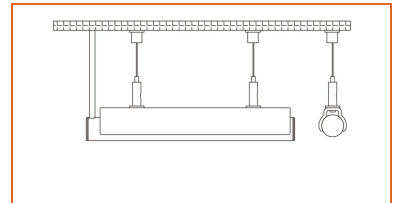

Telescoping clear bracket - open clip (Length: 20-39 inch)

Code LN360-TLC-O

Mounting Type

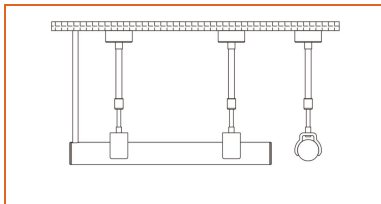

Telescoping clear bracket - closed clip (Length: 20-39 inch)

Code LN360-TLC-C

Mounting Type

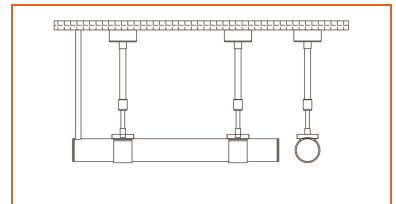

LINIO NEON 360°

Indoor/Outdoor · All-direction Bending · 360° Emitting



Telescoping clear bracket - low profile clip (Length: 20-39 inch)

Code LN360-TLC-L

Mounting Type

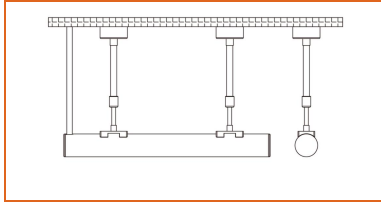
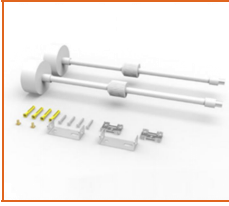

Telescoping clear bracket - PC channel (Length: 20-39 inch)

Code LN360-TLC-PC

Mounting Type

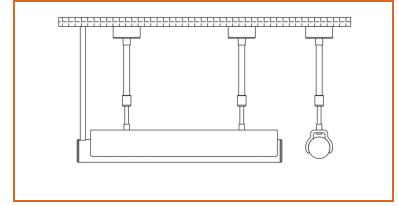

Vertical metal flush surface mount bracket - black

Code LN360-VB

Mounting Type

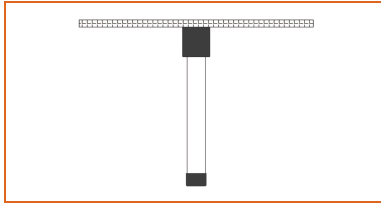

Vertical pendant suspended mount bracket - black

Code LN360-VSB

Mounting Type

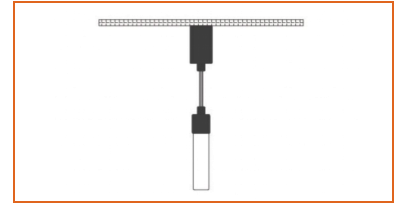

U-shaped metal flush mounting bracket - black

Code LN360-UB

Mounting Type

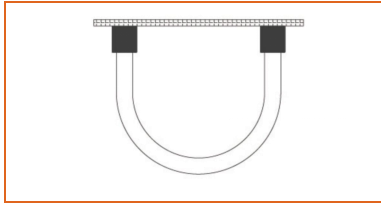

Metal joiner bracket - black (side cable entry only)

Code LN360-JNB-S

Mounting Type

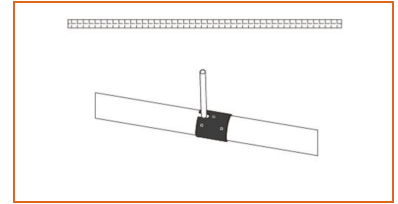

Metal joiner bracket - black (closed end cap)

Code LN360-JNB-C

Mounting Type

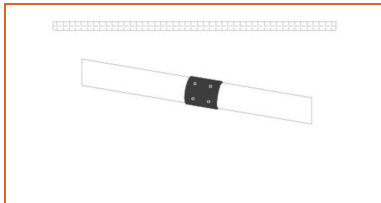

Joiner bracket - clear (side cable entry only)

Code LN360-JNC-S

Mounting Type

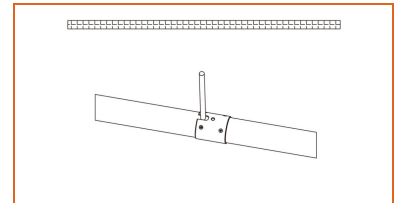
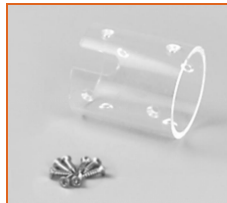

Joiner bracket - clear (closed end cap)

Code LN360-JNC-C

Mounting Type

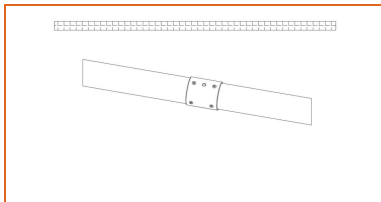

Suspended joiner bracket - clear (side cable entry only)

Code LN360-JSC-S

Mounting Type

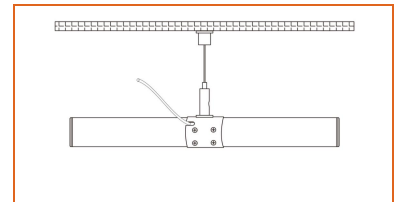

Suspended joiner bracket - clear (closed end cap)

Code LN360-JSC-C

Mounting Type

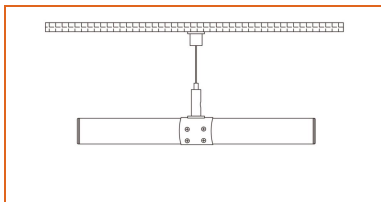

LINIO NEON 360°

Indoor/Outdoor · All-direction Bending · 360° Emitting



Power Supplies Options

Code	Max Load	Input	Output	Dimming		Environment	Size
XLG-150-24-A	150W	100-305VAC	24VDC	Non-Dim	Yes	Dry/Damp/IP67	180x63x35.5mm (L x W x H)
ELG-150-24B-3Y	150W	100-305VAC	24VDC	3 in 1 dimming		Dry/Damp/IP67	219x63x35.5mm (LxWxH)
ELG-150-24DA-3Y	150W	100-305VAC	24VDC	DALI control technology		Dry/Damp/IP67	219x63x35.5mm (L x W x H)
LPV-150-24	150W	180-305VAC	24VDC	Non-Dim	Yes	Dry/Damp/IP67	148x40x30mm (L x W x H)
LRS-150-24	150W	85-132V / 170-264VAC	24VDC	Non-Dim	Yes	Dry	99x97x30mm (L x W x H)
PWM-120-24	150W	90 ~ 305V / 127 ~ 431VAC	24VDC	3 in 1 dimming		Dry/Damp/IP67	191x63x37.5mm (LxWxH)

* Please refer to the spec sheet of each power supply for more detailed information

Accessories Options



Name Male and female connectors

Code MFC-2P-67

Male and female connectors with 30cm cable, IP67, 2 pin

Wiring Diagram

Non Dimmable

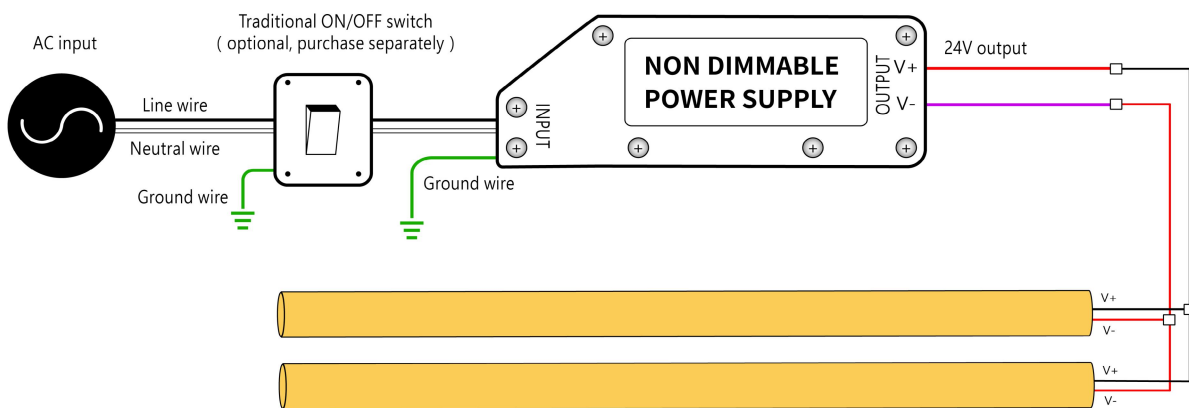

Dimmable

